



Manual
Precision Water Level Instrument
Model 6541C



Revision History

File name / Revision	Date	Author & Change Details	Checked / Approved
Previous version BX	2004	RS/ JH	
Unidata Manual - 6541 Precision Water Level Instruments Issue 2.1	2007	AB/CB/JH/MS/KC	
Unidata Manual - 6541 Precision Water Level Instruments Issue 2.2	2008	DM	
Unidata Manual - 6541 Precision Water Level Instruments Issue 2.3	2012	DM	
Unidata Manual - 6541 Precision Water Level Instruments Issue 3.0 - Reformat	17/09/2013	MP	
Unidata Manual - 6541C Precision Water Level Instruments Issue 4.0.docx	06 11 2014	CB/IM content Updated	CB

Copyright © Unidata Pty Ltd 2000-2013. All rights reserved. No part of this publication may be reproduced, transmitted, transcribed, stored in a retrieval system, or translated into any spoken or computer language, in any form or by any means. Electronic, mechanical, magnetic, optical, chemical, manual or otherwise, without prior written permission of Unidata Pty Ltd 40 Ladner St, O'Connor Western Australia 6163.



TABLE OF CONTENTS

1.0	6541C Water Level Instrument.....	1
2.0	Applications.....	2
2.1	Using the 6541	2
2.2	Features	2
2.3	Operating Modes	3
2.4	Models	5
2.5	Output Options	6
2.6	Float Systems.....	6
2.7	Micrologger Options	7
3.0	Logging Data	8
3.1	Creating a Scheme for Your Project.....	8
4.0	Preparing For Installation.....	13
4.1	Controls and Settings	13
4.2	Connecting a Battery Pack.....	13
4.3	Connecting to an External Data Logger via HSIO.....	13
4.4	Connecting More Than One Instrument to a Logger.....	14
4.5	SDI-12 Interface	15
4.6	Current Loop Interface (4-20mA)	16
4.7	Bench Testing the Instrument System	18
5.0	Site Installation.....	19
5.1	Installing the Instrument in the Recording Position	19
5.2	Installing the Float System	19
5.3	Setting the Instrument Water Level.....	20
6.0	6541C Applications	21
6.1	Measuring Surface Water Levels	21
6.2	Measuring Flow in Open Channels	21
6.3	Measuring Ground Water Levels.....	21
6.4	Floatwell Design for Water Level Measurement	22
6.5	Measuring Rainfall.....	22
6.6	Measuring Pan Evaporation	22
6.7	Floatwell Design for Water Level Measurement	23
6.8	Sources of Error in Float Systems.....	23
6.9	Causes of Error	23
7.0	Specifications: Model 6541C Instrument	25
8.0	Appendix A -8010C Micrologger.....	26
8.1	Specifications	26
8.2	Mounting.....	26
8.3	Other Connectors	27
8.4	The User Power Supply (UPS).....	28
8.5	Register Allocation	29
8.6	Field Installation.....	30
8.7	6541C-L 4-20mA Option	30
9.0	Appendix B - Details Of Unidata Float Systems.....	31
9.1	Float lines	31
9.2	Floats.....	31



9.3	Float Pulleys	33
10.0	Appendix C - Float Systems.....	34
10.1	Introduction to Float Systems.....	34
10.2	Sources of Error in Float Systems.....	34
10.3	Causes of Error	34
10.4	Reducing Errors.....	37
11.0	Appendix D – Floatwells.....	38
11.1	The Need for Floatwells	38
11.2	Floatwell Design	38
11.3	Mounting the Instrument on a Floatwell	39
11.4	Measuring Location	39
11.5	Other Features of a Floatwell Site.....	41

1.0 6541C WATER LEVEL INSTRUMENT

The 6541C is a float operated precision water level instrument. Float-operated instruments can be the most accurate way to monitor the level of a water surface. The Unidata Model 6541C Precision Water Level Instrument can achieve an operating accuracy and resolution of 0.1mm. This accuracy is maintained for the service life of the instrument without calibration or maintenance, apart from battery changes. The instrument has the range to monitor surface and underground waters, and the precision to monitor rainfall and evaporation.

The instrument is normally connected to the water surface by a float system. As the water level changes, this rotates the input shaft on which is mounted an optical encoder. The encoder is continuously monitored and the instrument tracks any water level changes updating the level displayed on the LCD display.

The very low mechanical friction and inertia of the instrument produce data of high precision and accuracy. A replaceable battery pack powers the instrument for more than 1 year.

2.0 APPLICATIONS

The 6541C series instruments can be used to monitor water level in a diverse range of conditions. Typical applications include monitoring water level in:

- Rivers, streams, canals, channels, sewers and drains — flow measurement.
- Reservoirs and lakes — management and water supply.
- Bores, piezometers, springs and soaks — aquifer studies and management.
- Harbours and estuaries — tidal and coastal hydrology studies.
- Rainfall captured in measuring tanks — long term precipitation data.
- Evaporation from measuring pans — automatic evaporation monitoring.

The float pulley can be changed to vary the units and resolution of the measurement.

2.1 Using the 6541

The 6541 is simple to install and use. At installation all adjustments are made using the switches located inside the front cover. Each instrument has a LCD display that shows the water level reading and updates automatically as the water level changes.

The instrument is powered by an internal pack of alkaline batteries with a service life of more than 12 months. The LCD will flash “Lo Batt.” when the battery pack nears full discharge and requires replacement.

2.2 Features

Most wiring connections to the 6541C Water Level Instrument are made by the front panel screw terminals.

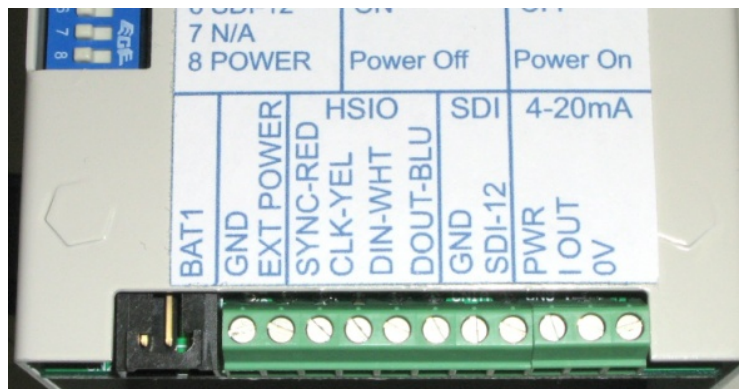

Power Supply: The instrument can be powered either from a Unidata battery pack plug or, via flying leads from an external power source.

HSIO: Access to 4 wires plus ground Unidata HSIO interface is provided by the front panel terminals. A “data in” terminal allows extension of a HSIO instrument chain. To connect to the 6541C, the Sync wire is red, the Clock wire is yellow, the Data In wire is white, and the Data Out wire is blue.

SDI-12: These terminals provide a connection point for the Version 1.3 compliant SDI-12 interface.

Current Loop: The 4-20mA current loop is a 3 wire optically isolated interface. It requires that the loop power be supplied by the logger end of the loop. To connect to the 6541, the Power wire is brown, the Ground wire is black and the Signal wire is purple. Note: The base level 6541C instrument is not fitted with the current loop interface.

2.3 Operating Modes

The operating modes of the 6541C WLI are set using the 8 DIP switches on the front panel.



Switch	Function	Off	On
1	DIR (Pulley Direction)	Clockwise	Counter Clockwise
2	PULLEY (Metric Pulleys) ^(see Note 1)	500mm / 1ft pulley	100mm pulley
3	UNITS (of measurement)	mm	Feet x.xx
4	FSD (Full Scale Deflection) Max. Count	See Note 2 below	
5	SIGNED		
6	Not Used		
7	SDI-12 Range Select	mm	metres
8	POWER	Instrument Off	Instrument On

Note 1: Table of pulley size and resolution -

<u>Pulley Circumference</u>	<u>Resolution</u>
100mm	0.1mm
500mm	1mm
1ft	0.01in

Note 2:

SW 4	SW 5	Range	Wraps (see Note 3)	Notes
Off	Off	0...65535	Yes	
On	Off	0...199999	Yes	Current loop and HSIO not available in these modes. Use SDI-12 (switch 6) instead.
Off	On	-199999...199999	No	
On	On	-199999...199999	No	

Note 3: If the range wraps, then when the level goes above the indicated maximum, it starts at zero again. Conversely, when the level goes below zero, it switches to the maximum value.

If the range does not wrap, then when the level goes beyond the indicated limits, it stops tracking water level changes and pegs the value at the limit. When the level moves back in the opposite direction, the level will immediately start counting again. This will introduce a progressively increasing offset error in the recorded level. For example, if the water level starts at 199990, increases by 20, then decreases by 15, the instrument will read 199984.

Note 4: SDI-12 Range Select will affect the SDI-12 data output format only, the units displayed on the LCD will not be affected.

In general there are three ways of using the 6541 -

1. With no data logger

As a water level measurement and display instrument the water level can be observed on the LCD display but measurements are not stored.

2. With an Internal Data Logger

As a water level measurement and display instrument with a built-in data logger – the 6541C-XX-C that can measure up to three additional external parameters.

3. With an External Data Logger

As a water level measurement and display instrument, with an external data acquisition facility such as a Unidata Starlogger. This is required when you need to measure many external parameters.

2.4 Models

The Model 6541C Instrument can be supplied in a number of versions to suit different applications. Versions are indicated by a three digit code appended to the instrument model number.

The example below shows the instrument with a 500mm pulley, alkaline battery and Unidata Micrologger fitted.

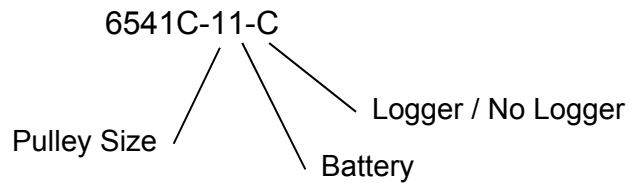

Config	Model 6541C-1x Model 6541C-2x Model 6541C-3x	500mm circ. pulley, metric, 1mm res. 1 foot circ. float pulley, Imperial, 0.01ft res. 100mm circ. float pulley, metric, rain, 0.2mm res.
Battery	Model 6541C-x0 Model 6541C-x1	No battery. Unidata Model 6910A Alkaline Battery Pack.
Logger	Model 6541C-xx Model 6541C-xx-C	Without Micrologger fitted. With Micrologger fitted.

Note: For Model 6541C-CL 4-20mA Output – contact factory.

2.5 Output Options

The instrument has three output interface options:

1. SDI-12 Interface.

The 6541C Water Level Instrument has a Version 1.3 - compliant SDI-12 sensor interface. The 6541C is powered all the time and measurements are instantaneously available allowing the use of the aR0! commands. The CRC-ed version of this command is also valid.

2. HSIO Interfaces

The 6541C has primary and secondary interfaces. The secondary HSIO interface is intended for connection to a Micrologger. When fitted with a Micrologger the 6541C becomes a standalone logging instrument.

This option is only available when the range is set to 0...65535. See 2.3 Operating Modes above for further information.

3. 4-20mA signal Population Option

This will produce an analog signal suitable for current loop instruments used in process control systems. The measurement range of the instrument is fully user-programmable over the output range.

This option is only available when the range is set to 0...65535. See 2.3 Operating Modes above for further information.

2.6 Float Systems

Unidata can supply the float systems required for accurate operation at your site. All float systems have associated errors. These are minimised by using the largest float that is practical. See Section 10.0 Appendix C - Float Systems on page 34 for more details of float systems.

2.7 Micrologger Options

The Micrologger is a factory fitted option that mounts within the water level instrument housing. When you use a Micrologger you do not require an external data logger to store water level measurements over time. The Micrologger has most of the features of a Unidata Starlogger and is operated in the same way using the same software as all other Unidata loggers.

The 6541C-XX-C instrument incorporates the Unidata 8010C Micrologger. See Section 8.0 Appendix A -8010C Micrologger on page 26 for details.

Water level is measured using the Micrologger's high speed serial IO channel. The Micrologger has two analogue inputs and two digital and inputs. It also has a counter input. You can use these inputs to measure other physical parameters such as rainfall, water or air temperature, barometric pressure and wind direction.

The 8010C Micrologger also includes one open collector output that can control an external device.

You should use the 6541-XX-C when you need to measure water level and a couple of other physical parameters.

3.0 LOGGING DATA

With the 6541C Precision Water Level Instrument connected to a Starlogger or Prologger or, when using the 6541-XX-C internal Micrologger; the water level sensed by the instrument is logged and stored according to a data logging program (called a Scheme), defined within the Starlog Software Package.

The Windows-based Starlog Software Package enables you to create a scheme and then download it to the Starlogger, Prologger or Micrologger.

The Starlog User Manual describes use of the Software Package.

3.1 Creating a Scheme for Your Project

A Scheme has to be loaded into each Unidata logger. Schemes are generally unique to a site or project.

The scheme instructs the logger:

- What instruments are connected
- How and when to log the data
- How to scale the acquired data
- How to format the output (defined as reports in the scheme).

3.1.1 Adding an Instrument to a Scheme

As the 6541C is a new instrument, you may need to add it to the **Instrument Library** in your software. In the **Scheme Editor**, click the **Instruments** icon. This will display the Scheme Instruments window.

Select an Instrument Library, then view the instruments listed. If this model of instrument does not appear in your instrument list(s), you may add it by clicking the New button.

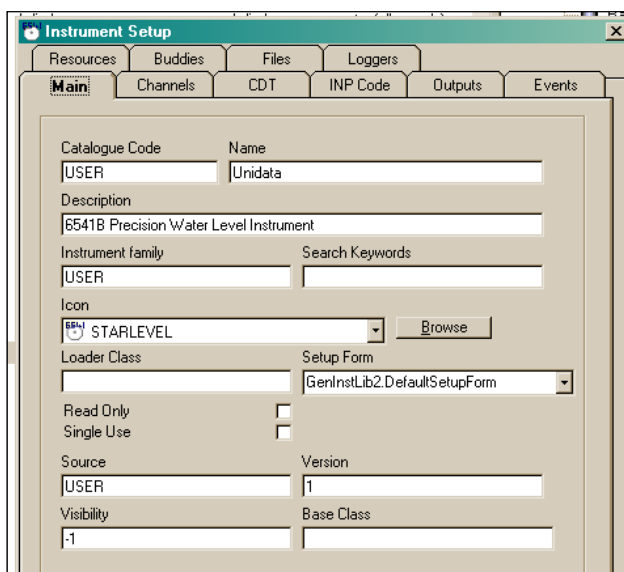

The new instrument will be shown as **User #1-User defined instrument**.

Double-click it to open the **Instrument Setup** screen.

You can now enter a name and description for the instrument, allocate a channel, the scaling factors, and other setup details.

If you are using an existing instrument from one of the libraries, then double-clicking on it from the Scheme Editor will allow you to check and adjust the scaling details appropriate to the instrument(s) in use.

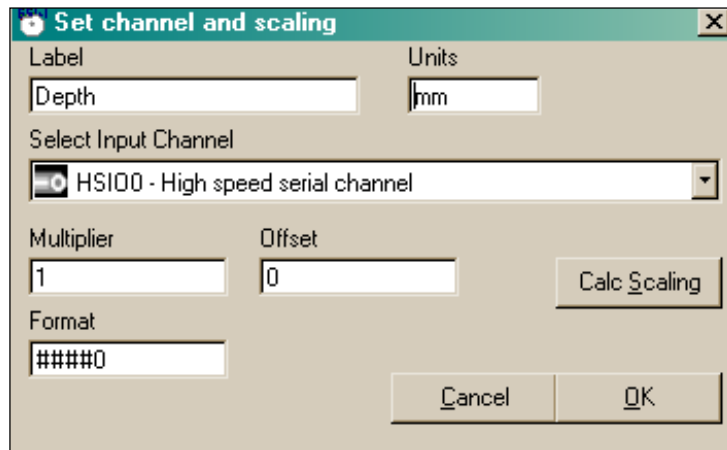

More examples of setup for alternative pulley diameters are shown below.

When you have finished entering or adjusting the instrument details, click the [OK] button.

If you choose to log data via a channel other than the default (channel S0), ensure the 6541C is connected to the correct terminal on the Field Termination Strip if you are using one, or the correct pin in the INPUT SIGNALS connector if you are connecting directly to a Starlogger. See your logger manual for details.

The connections described in this manual assume:

- In the case of Starlogger and Prologger connection, you are using the default serial channel, S0. Note that up to eight 6541C instruments can be connected to a data logger. If you want to connect more than one instrument nominate a different serial channel for each instrument.
- In the case of the 6541-XX-C (Micrologger version) see Appendix A.

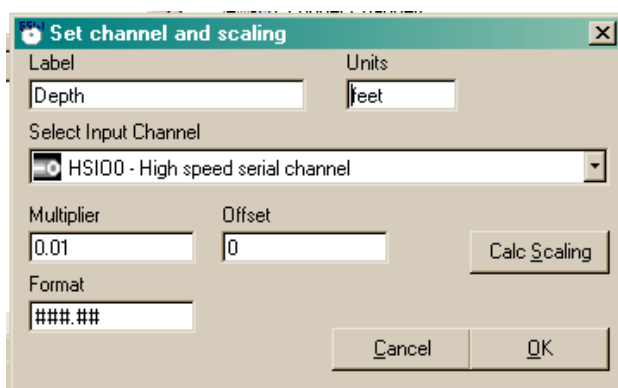

Model 6541C-2 Imperial Water Level
with 12 Inch Pulley
(used for general measurements).

Note that the data logged for units of feet is in feet and tenths of feet, not feet and inches. For example 2.5 feet, is not 2 feet 5 inches.

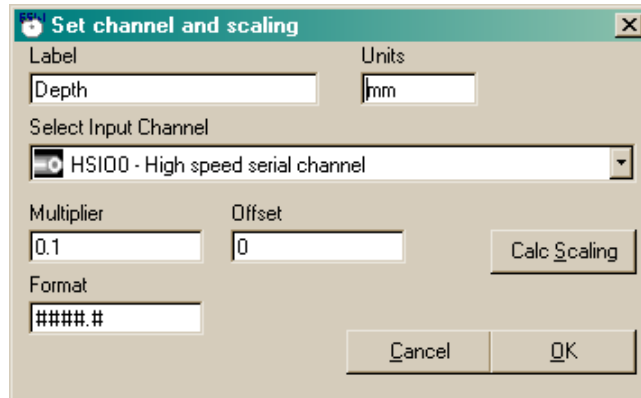

Model 6541C-3 Metric Water Level with 100mm Pulley
(used for precision measurements)

3.1.2 When to Log

When you log data you save it in the memory of the logger. This is the information that you record for later use. You can select what data to log, and when to log it, so the time series of data that you capture will suit your project and application. This is often a compromise between the memory size of the logger, the data detail that you wish to record, and how often you can unload and process the data.

The logger will read the 6541C at the scan intervals you select. You have the option of time based logging (e.g. each 15 minutes), event based logging (e.g. each time the water level changes 5mm) or a combination of time and events (say once each day and each time the level changes 10mm).

Time Based Logging

The default method is time based logging and this is typically used for water level measurement. The logging interval must suit the site conditions and project. For reservoirs and groundwater aquifers, water level may change slowly. In such cases logging the average water level each hour may be adequate. In larger rivers logging each 15 minutes may be suitable. The water level in smaller streams and drains can change rapidly and you may need to log each 1 to 5 minutes to capture the maximum rates of change that can occur. For rainfall or evaporation you may require hourly or daily totals or you may wish to log detailed data from which you can derive maximum rainfall intensities needed for design studies.

When you use Time Based Logging, memory usage is consistent and the time and date when the memory will be full can be predicted.

Three parameters define the time element of the logged data:

- Scan rate.
- Log interval.
- Log sub-interval.

The scan rate defines the frequency at which the logger “wakes-up” and interrogates the instrument. This is typically 5 seconds; however a shorter interval may be defined for better data definition or, a longer interval to conserve data logger battery power.

The log interval is the time between entries saved to the logger memory. The ideal log interval will capture adequate details for your project without wasting memory or producing unnecessary data.

Natural water levels may change slowly for most of the time except during very intense rainfall when rapid changes may occur. For many projects you will want to record these extreme events and will need to select your log interval accordingly. Key in the log interval, this must equal an even number of scans. Logs will be aligned to logical real times, e.g. hourly data will log on the hour.

The sub-interval allows you to average data over a portion of the log interval. For example, if you have selected a log interval of 1 hour and you enter a sub-interval of 5 minutes, the data you log (if you select (ave)) will be the average of all scans in the last 5 minutes of the log interval.

Event Based Logging

You can also define an event-based scheme. Event-based logging can extend the memory endurance by only logging when specific events are detected. A simple example of an event is; to log each time there is a level change greater than 5mm.

Water surfaces fluctuate by small amounts constantly. Avoid defining small increments (say 1mm) or the logger memory will be quickly exhausted.

Events are defined in the Event window. Each time a defined event occurs, the time, date and instrument value is logged.

Memory use depends on the rate at which the events occur. As a result memory use cannot be predicted with certainty when you use Event Based Logging.

3.1.3 What to Log

You specify what data is logged by checking the boxes for each instrument channel in the log buffer window, as shown on the next page.

The logging options are as follows:

- The data from the last scan (RAW),
- The average of some (ave) or all (AVE) scans or,
- The maximum (MAX) or,
- The minimum (MIN) scan

For example, with a time based scheme you may want to log the average value of all scans, and also the maximum during each log period.

Averaging data has the effect of smoothing out minor variations. It is a useful way of eliminating spikes caused by waves or ripples. Logging an average over a long period, say one hour, may de-sensitise the data. Using the sub-interval of say one minute would log the average of the last 1 minute of data in each hour.

Simply select as many log actions as required by checking the box in each required column on the line next to the instrument's channel.

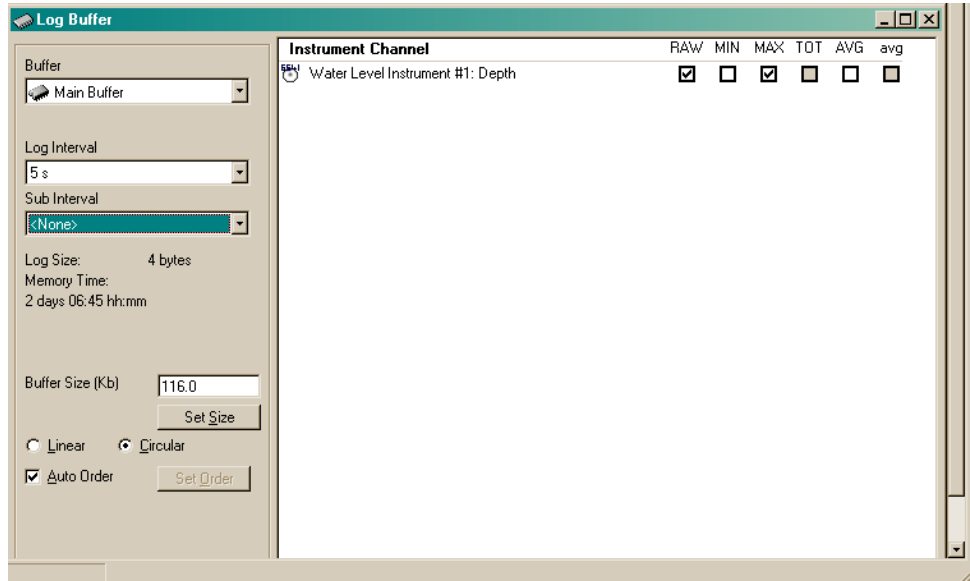

Save the scheme you have created, using a name to suit the site or project.

4.0 PREPARING FOR INSTALLATION

This section describes:

- The instrument options.
- How to connect the instrument to an external Unidata logger.
- How to test the system.

You should assemble and bench test a new system before installing it on site. Testing should include the logging and recovery of a period of data. This will allow you to confirm satisfactory operation of the entire system and for the site operators to become familiar with the instruments and software.

4.1 Controls and Settings

All the controls you need to install and operate the 6541C are accessed by removing the front cover.

The factory default switch settings are:

- Display counts up.
- Counts in (1mm) metric increments.
- Operates normally.
- Internal battery is OFF.

4.2 Connecting a Battery Pack

Plug in a model 6910A Battery pack to the socket located on the left-hand side.

4.3 Connecting to an External Data Logger via HSIO

Removing the front cover reveals a termination block to which the data logger cable is connected. This cable exits through the gland in the side of the instrument. External power may be connected to the designated terminals.

Precision Water Level Instrument		Starlogger		Prologger	
Wire Colour	Logger Function	Pin	Term	Pin	Term
Red	+5.00V DC sync (terminal 3)	13	15, 16 or 17	18	14
Green	(terminal 7)	23	14	28	17
White	DATA IN (s0) (terminal 5)				
Blue	DATA OUT (terminal 6)	21	11	32	11
Yellow	Serial CLOCK (terminal 4)	9	12	14	12

Notes

- Pin # refers to the pins of the INPUT SIGNALS connector on a logger.
- Term # refers to numbered screw terminals on a Field Termination Strip. This is the connection method you are most likely to use.
- Refer to the supplement included with your logger or Field Termination Strip for more information about these connections.

4.3.1 HSIO Interfaces

The 6541C has two HSIO interfaces. The primary interface is accessible via the screw terminals at the front of the instrument. The secondary HSIO interface is accessed by the IDC header located low on the rear of the PCB and is intended for connection to a Micrologger. When fitted with a Micrologger the 6541C becomes a standalone logging instrument.

The HSIO interface wiring shall be configured as below:

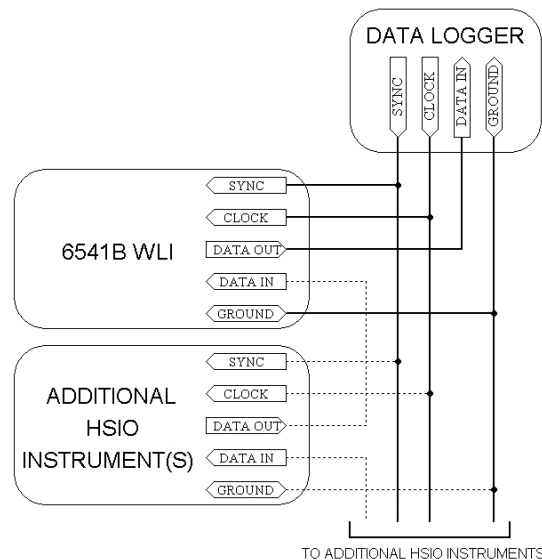

4.4 Connecting More Than One Instrument to a Logger

Each serial channel on a Starlogger or Prologger will support up to eight “daisy-chained” instruments. The first encoder’s DATA OUT (blue wire) connects to the logger’s serial channel input (S0); the second encoder’s DATA OUT (blue wire) connects to the first encoder’s DATA IN (white wire, S1) and so on.

The +5V DC (red), COMMON (green) and Serial CLOCK (yellow) signals must be connected in parallel at the logger or the adjacent encoder’s terminal block if that is more convenient.

4.5 SDI-12 Interface

The 6541C Water Level Instrument has a Version 1.3 - compliant SDI-12 sensor interface. As the 6541C generally has its own battery power source, only two wires are required for the SDI-12 communications. These are GND and SDI-12 for the data.

Generally SDI-12 sensors are not continuously powered and upon receipt of an SDI-12 command they need some time to take their measurements before reporting these measurements back to the recorder. The 6541C is powered all the time and measurements are instantaneously available allowing the use of the aR0! commands. The CRCed version of this command is also valid.

Note the valid addresses for the 6541C instrument are (ASCII) 0 → z inclusive. The address of the instrument is set to a default value of 0 at delivery.

4.5.1 Wiring Connections

Terminal 8	SDI-12 Signal
Terminal 7	SDI-12 GND

4.5.2 Commands

The SDI-12 commands below are useful for communicating with the 6541C Water Level Instrument.

Action	Command (to 6541C)	Response (from 6541C)
Acknowledge Active	a!	a<CR><LF>
Send identification	a!	a13Unidata 6541C 102<CR><LF> 13 ~ SDI12 Version 1.3 compliant 6541C ~ Product model number 102 ~ Firmware version is 1.02
Change Address	aAb!	b<CR><LF> Where "b" is the new address.
Address Query	?!	a<CR><LF>
Start measurement	aM!	a0001<CR><LF>
Send data	aD0!	a<value><CR><LF>
Continuous Measurements	aR0!	a<value><CR><LF>

In the commands:

- “a” is the sensor address.
- “!” terminates the command.
- “<CR><LF>” terminates the response from the instrument.

When requested via SDI-12 the 6541C will return the water level value shown on the LCD. The returned ASCII string will exclude any leading zeros. The exception to this is where the display has a 0 to the left of the decimal point. Hence if the LCD is displaying “000.09” the value returned is “0.09”.

4.6 Current Loop Interface (4-20mA)

The 6541C Water Level Instrument is available with a current loop output option. This provides a 4 to 20mA current loop output which is driven by a 16 bit converter on the main 6541C PCB.

The output loop compliance is from 0V → $V_{loop\ supply} - 2.75V$.

The zero level (4mA) and span level (20mA) points are programmable and once set are stored in non volatile memory. If these points require alteration, simply repeat the set up process entering the revised zero and span levels.

4.6.1 Wiring Connections

The 4-20mA output wiring shall be configured as below:

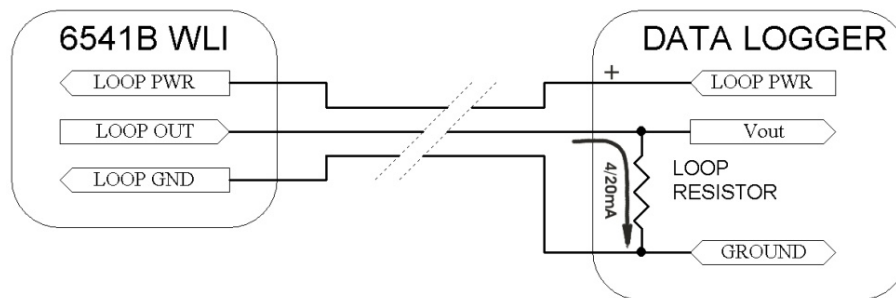

- The power for the current loop is to be provided from the data logger end of the loop. The power wire is purple, the ground wire is black.
- This voltage shall not exceed 24V.
- The output loop compliance is 0 → (Vcc-2.75V). The output wire is purple.

It should be noted that the three current loop connection terminals on the 6541C Water Level Instrument are electrically isolated from the remainder of the water level instrument circuitry via optocouplers.

4.6.2 Span & Zero Configuration

The “zero” value is the level for $I = 4\text{mA}$. The “span” value is the level for $I = 20\text{mA}$. To save power the 6541C zero & span values can be transposed providing a 20/4mA output.

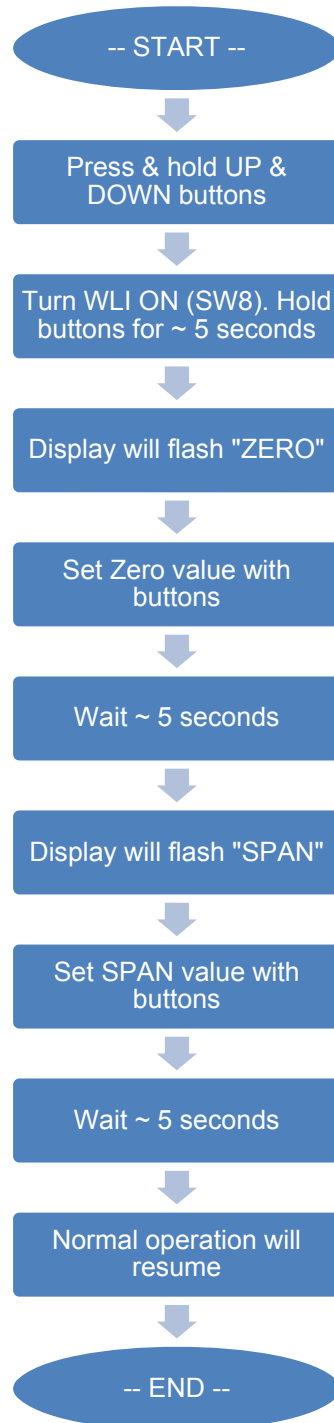

4.7 Bench Testing the Instrument System

If practical, assemble the equipment in the housings and on the mounting you will be using at the field site. This will ensure you have everything you need. When you have connected the instrument to the logger and selected the correct settings, you load the scheme into the logger.

Connect your PC to the logger and select the scheme you have prepared. Select “Program Logger with Scheme”, then “Scheme Test Mode”. The screen display should show the correct scheme details and the same value as displayed on the instrument LCD. When you change the level displayed on the LCD by rotating the float pulley wheel, the PC screen display should update each scan and display the correct value.

If you have a suitable test facility, set-up a temporary float system and install your instrument system. If possible, cause the “water surface” to slowly rise and fall and log the data. Check that the water level and the values on the LCD and PC test screen change in synchronisation.

After logging some data, unload and review it using the scheme report. Ensure the data you require is being logged and that the system is operating accurately.

Dismantle the system and pack it for transport to the installation site.

5.0 SITE INSTALLATION

The site should be constructed according to the instructions in the relevant appendices.

Installation of the instrument at your measuring location is a simple process if the system has already been prepared and bench tested. It generally involves the following steps:

- Installing the instrument onto the prepared floatwell.
- Installing the float system.
- Setting the water level display.
- Mounting and cabling.

5.1 Installing the Instrument in the Recording Position

The Water Level Instrument should be installed on a shelf or bracket suitably positioned over a bore or stilling well. The face of the pulley must be vertical otherwise the float line may be dislodged as the pulley rotates.

It is designed to connect to a Logger via a 4-wire cable less than 5 metres long (see note in connection details for cable lengths up to 10 metres). The cable is fed into the instrument through a cable gland in the base.

The Water Level Instrument should be protected from direct weather by a shelter. It is not waterproof.

5.2 Installing the Float System

A float system consists of a float, with a floatline and counterweight. This system has to be installed so it turns the float pulley while the float moves through the complete range of water level measurements required.

To install the float system, do the following:

1. Select a float line of sufficient length. Handle it carefully as any kinks, particularly in a beaded float line, may cause failures.
2. Attach the counterweight using the swages supplied to crimp a secure loop through the counterweight eye.
2. Lower the counterweight into the well until it touches the well bottom or is below the minimum level to be measured.
3. Pass the float line over the float pulley of the instrument and back below the instrument bracket, to a point above the maximum level to be measured.
4. Cut the float line to this length and form a loop through the float eye.
5. Lower the float, rest it on the water surface and let it float free.
6. Position the floatline in the groove of the float pulley. If you use beaded cable, turn the pulley to engage the index beads into the holes in the float pulley groove.

5.3 Setting the Instrument Water Level

To do this:

1. Remove the front cover of the instrument.
2. Set the battery switch (number 8) to the ON position.
3. Use the buttons to set the LCD display to read the approximate water level value.
4. Turn the float pulley to simulate an increase in water level. Confirm that the LCD increases. If it changes in the wrong direction change the position of switches 1 and 2.
5. Rock the pulley a little to disturb the water surface. The display should move up and down and settle on the same level ($\pm 1\text{mm}$) each time. If it doesn't, the float system is not moving freely. The float, line or counterweight may be rubbing on an obstruction or the instrument pulley may have on its shaft.
6. Use the buttons to adjust the display to the exact value.

The water level that you set should be referred to a site datum. This datum should originate from a fixed point that will not change during the period of the measuring project.

The value displayed should be set high enough so that changes in the water level do not move outside the set range (see Section 2.3 Operating Modes on page 3). If the pulley shaft is rotated so that the reading goes out of range, the value will either “wrap around” or be pegged to the limit.

For instance, if you are measuring a bore with water level 20 metres down; set the display to 20 metres (20000). When the water level rises, the reading will change to 19999. When the water level falls, the reading will change to 20001.

6.0 6541C APPLICATIONS

The 6541C is suitable for a wide variety of applications. These include measuring:

- Surface water levels.
- Flow in open channels.
- Ground water levels.
- Pan evaporation.

6.1 Measuring Surface Water Levels

Water levels in lakes, reservoirs, tidal estuaries and process tanks are monitored for research and management. The 6541 mounted on a suitable floatwell will provide accurate and reliable data in these applications.

6.2 Measuring Flow in Open Channels

When measuring the flow in open channels it is common to measure the water level and convert this into a flow rate using a stage/flow relationship derived from theory or actual measurements. This relationship can be entered into Unidata loggers as a formulae or look-up table. The flow rate can then be logged instead of, or in addition to water level. The accuracy of this practice depends on how well the level/discharge relationship can be defined, and how stable this is. At many sites the Unidata Model 6256 Starflow system will be a better option for flow measurement.

In small channels it is common practice to construct a small weir, flume or other measuring structure at a location where all flow passes through. There are many different types of measuring structures. In larger channels measuring weirs may be constructed that combine some form of calibrated structure for small flows and a natural channel for larger flows.

The location and design of measuring sites is covered in many standard texts on hydrology, fluid mechanics and water resources monitoring. The selection of a suitable site and measuring structure is essential. It is important to understand the accuracy and limitations of different structures. Poor flow data may result from an unsuitable site or structure design, despite the measurement of accurate water level.

6.3 Measuring Ground Water Levels

A borehole can be used as a floatwell provided it is large enough and straight enough to allow a float system to operate accurately.

Please see the section Sources of Errors in Float Systems in Section 10.0 Appendix C - Float Systems on page 34.

An additional source of error in the boreholes is that a floatline will tend to *cling* to the wet sides of the bore casing if it touches. This can cause large errors in small boreholes and will happen if the boreholes have not been drilled vertically or straight.

6.4 Floatwell Design for Water Level Measurement

A floatwell or stilling well is required at any site where a 6541C instrument is used. At many sites floatwells are simple devices that can be constructed from lightweight materials such as PVC pipe. On larger rivers constructing new floatwells can be uneconomic and alternative instruments such as Unidata Pressure transducers should be considered.

The water surface in a natural channel frequently surges and swirls with the velocity and is disturbed by waves and ripples. These cause the float to move and bounce around and this affects the accuracy of the logged waterlevel. A floatwell creates a still water surface that moves with the major changes of the waterlevel, but not the minor ones.

Data accuracy and reliability will be improved if:

- There is a stable mounting for the instrument. Movement of the 6541C will appear as a water level change
- The instrument is protected and kept dry, clean and secure,
- The cable to the data logger should be protected from damage.

6.5 Measuring Rainfall

Float instruments producing graphical charts were historically used for rainfall measurement. During the last 30 years these were superseded by tipping bucket rain gauges that produced high resolution digital data. These instruments also introduced calibration drifts and reliability uncertainties not experienced with float instruments.

The Model 6541C instrument has the precision to measure rainfall. Fitted with a 100mm circumference pulley the 6541C will measure water level to a resolution of 0.2mm. An imperial version fitted with a 5" circumference pulley will measure in points (1/100"). These instruments can be used as a simple pluviograph to produce accurate and reliable rainfall data.

The rainfall funnel is connected to a tank with a known diameter. A float on the water surface is connected to the instrument. Rainfall accumulates in the tank and evaporation is prevented by a layer of light oil on the water surface. The instrument scaling in the scheme converts changes in water level in the tank to rainfall in millimetres.

The tank storage capacity should be sufficient not to be exceeded between visits by servicing staff. A sight tube allows the total rainfall to be read and a drain valve is used to reset the tank water level for another period of data.

An option can be provided to automatically drain the water from the tank whenever it reaches a preset level.

6.6 Measuring Pan Evaporation

Pan evaporation is frequently measured as the total daily change in the water level in a measuring pan. A manual observation is generally taken at the same time each day. Associated readings of rainfall, water temperature and wind run are usually also taken.

Unidata Model 6529 Version 2000 uses the Model 6541-31-C in a USGS Class A evaporation pan to a resolution of 0.2mm.

The integrated Micrologger computes the accumulated evaporation and rainfall for logging. It uses an additional card to control the water level in the evaporation pan.

6.7 Floatwell Design for Water Level Measurement

A floatwell or stilling well is required at any site where a 6541C instrument is used. At many sites floatwells are simple devices that can be constructed from lightweight materials such as PVC pipe. On larger rivers constructing new floatwells can be uneconomic and alternative instruments such as Unidata Pressure transducers should be considered.

The water surface in a natural channel frequently surges and swirls with the velocity and is disturbed by waves and ripples. These cause the float to move and bounce around and this affects the accuracy of the logged water level. A floatwell creates a still water surface that moves with the major changes of the water level, but not the minor ones.

Data accuracy and reliability will be improved if:

- The instrument has a stable mounting. (Movement of the unit will appear as water level change)
- The instrument is protected and kept clean, dry and secure
- The cable to the data logger is protected from damage.

6.8 Sources of Error in Float Systems

All float systems are subject to a range of minor errors. The errors involved in the recordings made by a properly designed float operated level recorder are generally too small to be of great importance. However, the user should be aware of potential sources of error and how to compensate for them. These errors can become significant at sites where a large measuring range is proposed.

Significant source of error can occur at sites such as reservoirs and bores where large variations in water level are recorded. When the float movement exceeds 10 metres, special components or designs may be required. This is because the net weight of the floatline transfers from one side of the pulley to the other. In extreme cases the float may be lifted from the water by the weight of the line on the opposite side of the pulley and *run away*.

The endless floatline is an alternative that eliminates the transfer of weight from one side of the float to the other, and the errors so induced. It also solves the problem of line “run away”.

6.9 Causes of Error

The main causes of error in float line level measurement are:

- Float line shift.
- Submergence of counterweight.
- Instrument lag.
- Temperature change.



Other minor causes relate to humidity and water saturation of wooden supporting structures and the expansion of such structures resulting from changes in temperature and water content.

Note: Causes of error, corrections and error reduction are fully described in Section 10.0 Appendix C - Float Systems on page 34.

7.0 SPECIFICATIONS: MODEL 6541C INSTRUMENT

Range:	-199999 to 199999mm.
	Switch to 6553.5mm/19999.9mm, 655.35'/199.99" or 655.35" to suit the float pulley used.
Resolution:	1.0mm or 0.1mm, 0.01' or .01", depending on the range selected.
Accuracy:	1 resolution increment, with suitable float system.
Tracking:	Up to 1 shaft revolution per second. (500mm per second for standard unit).
SDI-12:	Compliance: Version 1.3 Mode: Sensor
HSIO Output:	High speed serial signal Unidata HSIO standard. Options for 4-20mA and dual HSIO channels. Data in, Data out, Sync, Clock
Current Loop:	Range: 4-20 mA Span / Zero: User programmable DAC Resolution: 16-bit Up to 8 instruments can be daisy chained.
Environmental:	Operating Temp: -10 ↔ +60° C Humidity: 0-100%, non-condensing.
Power:	Internal Alkaline battery pack. Expected life exceeding 12 months. External Supply: 7.5 – 24V DC Exchange battery pack Unidata Model 6910A.
Display:	6-digit LCD with low battery indicator.
Construction:	Exterior PVC, Aluminium and stainless steel.
Housing:	Sealed PVC enclosure - IP65.
Size:	Width 180mm, height 275mm and depth 140mm
Weight:	2.7 kg, including battery.

6541C Instrument + Micrologger

Same as above but with a Model 8010C Micrologger installed. See Section 8.0 Appendix A -8010C Micrologger on page 26 for details and specifications of the Micrologger.

8.0 APPENDIX A -8010C MICROLOGGER

The 6541L is a variant of the Unidata Model 8007B Micrologger, designed to be used with Model 6541 Precision Water Level Instrument.

The MicroLogger is program compatible with the Starlogger, supporting many of its extended features such as SDI-12 and HSIO communications.

8.1 Specifications

Memory:	512K RAM & Reprogrammable 8K EEPROM
Inputs/Outputs:	1 x 16 bit Counter Channel 2 x Analog Channels Hi-res 0...2.5V scaled 1.221mV/bit - A0 & A1 2 x Digital Inputs (Potential Free) Log Start, SENSE 1 1 x High Speed Serial I/O Channel 1 x Open Collector control output OUT 0 Precision 5V Reference scan synchronised with pre-scan Analog and Digital Ground
Power:	Operating voltage 6.8 to 18VDC (6V if 5V Ref is not required) Operating current: 60mA; standby current: 50µA UPS (User Power Supply) may be regulated to any voltage up to battery Battery Voltage measurement (100mV/bit) A2 Low Battery Detect & Shutdown (hardware & firmware)

8.2 Mounting

6 × M3 mounting holes.

8.2.1 Signal Connections

RS-232 DB-9 CONNECTOR	
Pin	Description
1	Carrier Detect
2	Receive Data
3	Transmit Data
4	Data Terminal Ready
5	Ground
6	Data Set Ready
7	Request to Send
8	Clear To Send
9	Ring Indicator

Signal Communication Terminals		
Pin	Label	Description
1	UPS	Output
2	GND	Digital/Power Ground
3	OUT0	Open Collector Control Output
4	INP0	Digital Input (Log Start)
5	GND	Digital Power Ground
6	C0	Counter 0 Input
7	AREF+	+5V Scan Sync
8	A0	Analog Channel A0 Input
9	AGND	Analog Signal Ground
10	A1	Analog Channel A1 Input
11	EPWR	External Power (for SDI-12 Devices)
12	SDI	SDI-12 Signal
13	GND	Digital/Power Ground (for SDI-12 Devices)

8.3 Other Connectors

There are two other connectors on the Micrologger PCB:

- 10 Way Header - alternative RS-232 port. The cable can be supplied for this port.
- 14 Way Header - connects to the encoder PCB.

8.4 The User Power Supply (UPS)

In the MicroLogger, the UPS may be used in two modes. The default mode switches the UPS on every scan, with the pre-scan defined in the CDT (default 15ms). The other way is to enable the UPS as programmable (set Byte 10, Bit 3 of the CDT). In this mode, a new instruction is available to control the UPS.

The UPS Instruction has this form (op-code 132):

UPS, #_of_ON_scans, Pre-scan_in_15.625ms_(lsb/msb)

of On scans = 0 = UPS remains OFF

1 = UPS ON next scan only

2-255 = UPS ON next 2...255 scans

Pre-scan = 0 = UPS turns ON after I/O measurement

1 = UPS turns ON at I/O measurement (no prescan)

2 = UPS turns ON 15ms before I/O measurement

Example

132, 4, 64, 0

This example instruction switches ON the UPS 1 sec ($64 \times 15\text{ms}$) before the next scan and leaves the UPS ON for 3 more Scans (4 in total).

Hardware Setting for UPS Instruction – To use the UPS Instruction, ensure that Jumper #4 and Jumper #6 are linked. This connects the timer to the UPS counter and the UPS output to the terminal block.

Pulse and Switch Instructions – Pulse (op-code 24/26) and Switch (op-code 25/27) instructions can be used to program the UPS (Channel #1) if the UPS is configured in programmable mode (see above). (Channel #0 is the open collector output).

8.5 Register Allocation

The Model 6541L MicroLogger operating the standard instruction set has the following fixed memory assignments in the Hardware Register:

Address	Size	Description
0	1	Software Revision Number (20 onwards)
1	2	Logger runtime in milliseconds (16 bit integer)
3	1	Error flags
4	4	Logger scan counter (32 bit integer)
8	1	Reserved
10	1	Reserved
11	2	msb of address (bits 8-23) used in LDBLK and MVBLK instructions
13	2	Reserved
14	1	Binary states of analog channels
16	1	Analog channel (a0) unsigned low resolution representation (8 bit)
17	1	Analog channel (a1) unsigned low resolution representation (8 bit)
24	2	Counter channel (C0) 16-bit
32	1	Digital input values (normally high) Bit 3 Log Start Detect:Log Start;in memory Bit set=not detected Bit 6 High speed serial Data 0
33	1	User Power Supply status register Bit 0 = 1 UPS will be ON next scan Bit 1 = 1 UPS was ON for this scan Bit 2 = 1 UPS is currently ON Bit 7 = 1 (set by log program) to synchronize UPS to come on next scan (auto reset).
34	1	Arithmetic status register set by ADD, SUB, MUL, DIV instructions. Bit 2 = Arithmetic overflow Bit 7 = Arithmetic carry Logic status register set by CMP (compare) instruct. Bit 4 set Operand 1 =Operand 2 Bit 5 set Operand 1 < Operand 2 (unsigned) Bit 6 set Operand 1 < Operand 2 (signed)
35	1	Reserved
80	6	Version 2 Software stores Scheme Name here.
200	2	Analog channel (A0) signed 16 bit channel
202	2	Analog channel (A1) signed 16 bit channel
204	2	Battery voltage measurement (A2)

8.6 Field Installation

Do the following:

1. Unscrew the lid of the 6541 andC remove the battery pack.
2. Remove the four screws that secure the metal frame on which the PCB and LCD are mounted.
3. Remove the cable between the PCB and the instrument from the top of the instrument housing.
4. Connect the dual-output PCB to the main PCB using the 14 pin header cable supplied and then mount the dual output PCB on the main PCB.
5. Re-connect the cable to the instrument - see the illustrations for the correct orientation.
6. Re-fit the PCB bracket.
7. Re-connect the battery pack and then replace the cover on the unit.

8.7 6541C-L 4-20mA Option

The 6541C-L 4-20mA option converts the digital level value from a 6541C Precision Water Level Instrument to an analog 4-20mA signal. This option may be fitted in the factory by Unidata.

For more details refer to section 4.6 Current Loop Interface (4-20mA) on page 16.

9.0 APPENDIX B - DETAILS OF UNIDATA FLOAT SYSTEMS

Unidata manufactures a range of float systems and accessories to suit the requirements of various customers. These products are available as options for the new 6541C Precision Water level Instrument. Each float is supplied with floatline swages and a 160g lead counterweight (epoxy painted).

9.1 Float lines

A range of special stainless steel float lines are available to suit different applications.

Model 6541D-U 1mm stainless steel floatline without beads.

Model 6541D-M 1mm stainless steel metric floatline with brass beads with 125mm spacing

Model 6541D-I 1mm stainless steel imperial floatline with brass beads with 3 inches spacing

Model 6541E 0.4mm diameter lightweight and flexible floatline for use in boreholes and with small diameter float pulleys.

9.2 Floats

9.2.1 Model 6541F-170

This float is designed to produce high precision data at most sites with 6541C Instruments. It is constructed of PVC and may be used in floatwells with a minimum diameter of 200mm. The float has a cylindrical shape with a flat bottom for maximum sensitivity. It is suited for use at intermittently dry wells where the float may rest on the bottom.

Dimensions: Cylinder 170mm diameter and 85mm high.

Materials: PVC pipe and fittings.
Stainless Steel eye bolt for float line.
Ballasted to float at the centreline when used with a 160g counterweight.

Weight: 1122g.

9.2.2 Model 6541F-115

This float is suitable for sites where a 6541C is installed and the water level range is small, or a lightweight floatline is used. This float is designed for use in a floatwell with a minimum diameter of 150mm. The float has a cylindrical shape with a flat bottom for maximum sensitivity. It is suited for intermittently dry wells where the float may rest on the bottom.

Dimensions: Cylinder 115mm diameter and 60mm high.

Materials: PVC pipe and fittings.
Stainless Steel eye bolt for float line.
Ballasted to float at the centreline when used with a 160g counterweight.

Weight: 500g.

9.2.3 Model 6541F-90

This float is suitable for sites with a small water level range or where a lightweight floatline is used. The float is designed for use in a floatwell with a minimum diameter of 125mm, or 100mm if a separate counterweight tube is used. The float has an ovoid shape and is weighted to float on the centreline.

Dimensions: Ovoid float 88mm diameter, 130mm long.
Maximum diameter is 92mm at the join.

Materials: Moulded black thermoplastic.
Stainless steel fitting for float line.
Weighted to float at the centreline when installed with a 160g counterweight.

Weight: 530g.

9.2.4 Model 6541F-60

This float is suitable for sites where a 6541C is installed and the water level range is small, or a lightweight floatline is used. This float is designed for use in a floatwell with a minimum diameter of 150mm. The float has a cylindrical shape with a flat bottom for maximum sensitivity. It is suited for intermittently dry wells where the float may rest on the bottom.

Dimensions: Cylinder 60mm diameter and 140mm high.

Materials: PVC pipe and fittings.
Stainless Steel eye bolt for float line.
Ballasted to float at the centreline when used with a 160g counterweight.

Weight: 414g.

9.3 Float Pulleys

Pulley	Type	Model	Usage
500mm circumference	Metric	6541P-M500	Use with 1mm cable with optional beads each 125mm.
12" circumference	Imperial	6541P-I12	Use with 1mm cable with optional beads each 3 inches.
100mm circumference	Metric	6541P-M100	Use with 0.4mm cable.

10.0 APPENDIX C - FLOAT SYSTEMS

10.1 Introduction to Float Systems

Float systems used for monitoring water level usually consist of a sealed float connected to a floatline that passes over a pulley on a measuring instrument. A counterweight is connected to the end of the floatline to maintain tension. The pulley over which the floatline passes is connected to a shaft. As the water level changes, the float moves up and down rotating the shaft of the instrument. The instrument records the water level.

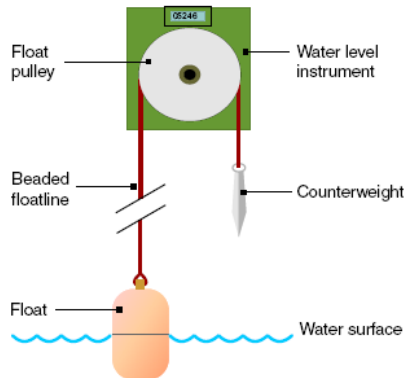

Float systems are subject to a range of errors. These are explained in the following sections. Floats above 150mm in diameter give good results ($\pm 1\text{mm}$) for small ranges of water level. To accurately measure larger ranges of water level, floats of 200mm are required.

It is important that you select a float system that can deliver the level of accuracy required.

10.2 Sources of Error in Float Systems

All float systems are subject to a range of minor errors. The errors involved in the recordings made by a properly designed float-operated level recorder are generally too small to be of great importance. However, the user should be aware of potential sources of error and how to compensate for them. These errors can become significant at sites where a large measuring range is proposed.

Significant source of error can occur at sites such as reservoirs and bores where large variations in waterlevel are recorded. When the float movement exceeds 10 metres, special components or designs may be required. This is because the net weight of the floatline transfers from one side of the pulley to the other. In extreme cases the float may be lifted from the water by the weight of the line on the opposite side of the pulley and *run away*.

The endless floatline is an alternative that eliminates the transfer of weight from one side of the float to the other, and the errors so induced. It also solves the problem of line “run away”.

10.3 Causes of Error

The main causes of error in float line level measurement are:

- Float line shift.
- Submergence of counterweight.
- Instrument lag.
- Temperature change.

These causes of error are discussed below:

Other minor causes relate to water density and the movements of supporting structures and the expansion of such structures resulting from changes in temperature and water content.

10.3.1 Float Line Shift

With every change in water level, a portion of the float line passes from one side of the float pulley to the other side. The *weight of the line* changing from one side of the pulley to the other affects the depth of flotation of the float. This causes an error in the registered level.

The magnitude of this error varies with the amount of line shifted (i.e. the amount the level has changed since the recorder was set to a known reference), the weight of the line and the size of the float.

Typical float line weights are:

125mm beaded float line	= 6.0 grams/metre
0.4mm float line	= 1.2 grams/metre

For levels rising above a given reference (starting point) this error will make the level measure slightly high, for a level falling below the reference point the error makes the level appear low.

The amount of error may be calculated using **Formula 1** on the following page. The error is inversely proportional to the square of the float diameter. That is, the larger the float, the smaller the error.

The error is slightly different for a float line submerged in water (as in the case of a counterweight being below the float). **Formula 2** on the following page should be used for submerged float line shift corrections.

10.3.2 Submergence of Counterweight

When the counterweight (and any portion of the float line) becomes submerged, the pull on the float is reduced and its depth of flotation is reduced.

In this case the level will measure slightly lower than it actually is. The amount of this error may be calculated from **Formula 3** (on the following page).

10.3.3 Instrument Lag

A certain amount of force is required to move the shaft mechanism of the level measuring instrument and also to bend the float line over the float pulley. This force must be supplied by the pressure of the water on the float.

This error (caused by friction in the measuring apparatus) is not cumulative and is usually not very large. **Formula 4** (on the following page) details the error caused by instrument lag.

10.3.4 Temperature Change

Changes in temperature will cause the float line to expand and contract. The amount of expansion (contraction) is usually small and is often compensated by the simultaneous expansion (contraction) of the level instrument supporting structures. The floatline length change can be calculated from **Formula 5** below, using the following factors.

10.3.5 Coefficients of Expansion

Float Line	Coefficient	X Factor
1.2mm SS Beaded Cable	0.0000009	0.0009mm/°C/metre
0.4mm Stainless Steel	0.0000009	0.0009mm/°C/metre
Supporting concrete	0.0000065	0.0065mm/°C/metre

Therefore the error expected from a 10°C change in ambient temperature for a 10 metre cable will be 0.9mm (the float line expands/contracts by 0.009mm/°C/metre).

10.3.6 Correction Formulae

Formula 1 $E = 2560 \times (W/D^2) \times S$

Formula 2 $E = 2350 \times (W/D^2) \times S$

Formula 3 $E = 117 \times (C/D^2)$

Formula 4 $E = 2560 \times (F/D^2)$

Formula 5 $E = X \times T \times L$

where:

E = measurement error in millimetres.

W = weight of float line in grams/metre. (6.0 for beaded cable, 1.2 for 0.4mm cable).

D = diameter of float in millimetres.

C = weight of lead counterweight in grams.

F = frictional force within the instrument in grams (F = 1.0 for Model 6541A Water Level Instrument.)

T = ambient temperature change in °C.

S = shift of line level in metres.

L = length of line between instrument and float.

X = Coefficient of expansion (X Factor).

10.3.7 Example

A water level instrument has an 85mm diameter float, a beaded stainless steel cable and a 160gm counterweight (always above the float). What errors would occur if the level rose by 2 metres? (In this case we will ignore temperature changes as there is no information about the supporting structures).

From Formula 1, the error in measurement would be 4.2mm too high. The error due to Instrument Lag Formula 4 is 0.3mm and the total error 4.6mm. As the counterweight goes underwater a 2.6mm error occurs.

This example demonstrates the large errors that can result from the use of unsuitable components. If the recommended 170mm float was used in the system described in the example, the line shift error would be 0.77mm, the instrument lag 0.09mm; a total of 0.86mm, and the counterweight submergence error would be 0.46 mm.

10.4 Reducing Errors

The following hints will assist in reducing errors in float operated level measurement systems.

- Use the largest diameter float possible (reduces all errors).
- Use a lightweight float line (reduces line shift).
- Make sure the counterweight is always above or always below the float (eliminates counterweight submergence errors).
- Mount the level measurement instrument as close to the level being measured as possible (reduces temperature errors).
- Use a computer to apply automatic correction for all errors from a known reference level.

11.0 APPENDIX D – FLOATWELLS

11.1 The Need for Floatwells

If a float is located on open water, it can be affected by waves, wind and water movement. If any of these influences are strong enough to interfere with the position of the float, inaccurate measurements will result. A typical example is where the float is washed out of position by a strong current. To ensure such external influences do not affect the measurement, you will need to use a floatwell (stilling well).

11.2 Floatwell Design

A floatwell must be designed to suit the conditions at the measurement site. Small sites may only require a simple PVC cylinder one or two metres in length. For larger sites, you may require steel or concrete structures to protect the float from high water velocity and debris. More sophisticated structures may require professional design.

Floatwells can stand in the water attached to a post or pier, or can be buried in a concrete structure or a river bank. Water normally enters through holes in the wall of the well or through inlet pipes.

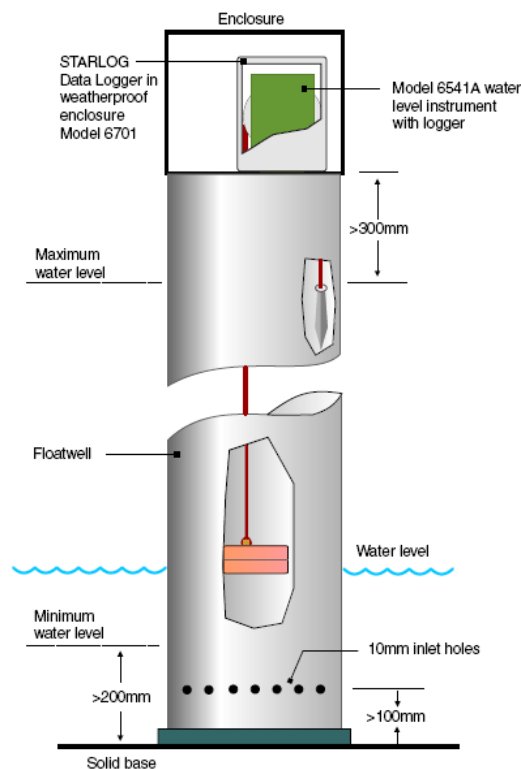

To operate correctly, a floatwell must have the following features. It should:

- Have sufficient internal diameter to accommodate the float used with the measuring instrument.
- Be long enough to allow the float system to move freely from the minimum to the maximum water levels expected at the site.
- Be blocked at the bottom and fitted with restricted inlets that allow the internal water level to change with outside levels, but exclude the effects of outside waves and surges. Several such inlets should be used.
- Be designed to protect the float system from damage or interference.
- Be fitted with a cabinet or housing to protect the instruments.
- Be accessible to operators.

11.3 Mounting the Instrument on a Floatwell

The recording instrument must be mounted over the float well so that the float and counterweight hang clear of the wall and can move freely through the full measurement range. If the floatwell is small, a separate pipe can be used for the counterweight or offset guide pulleys can be used to re-direct the floatline to a better location.

The instrument mount should be solid and not allow any vertical movement of the instrument itself. Any such movement will be recorded as a change in the water level. Also, some sort of housing or cabinet is required to protect the instrument from the weather, interference or damage.

11.4 Measuring Location

The floatwell must be located where it will measure the required water level. In addition to the location of the floatwell there are several other issues that must be considered before selecting the site and final design.

- Water velocity.
- Siltation.
- Environmental impact.
- Access and security.

Note that if a calibrated measuring structure such as a weir or flume is being used, there will be a specific location at which the water level must be measured.

11.4.1 Water Velocity

If the site is a large still water body such as a lake, pond or reservoir, the water will be horizontal and the level can be accurately measured anywhere.

If the water is flowing, the water surface will be sloping. The faster the water is flowing, the larger the slope will be. The measuring location will need to be the point of interest as the varying slope will introduce different errors in different conditions.

If the water velocity is too high, it can begin to affect the water level inside the floatwell by causing a venturi effect on the inlet holes. This effect can be minimised if the intake holes are located on the upstream and downstream sides. It can be eliminated if a static tube is used on an inlet pipe.

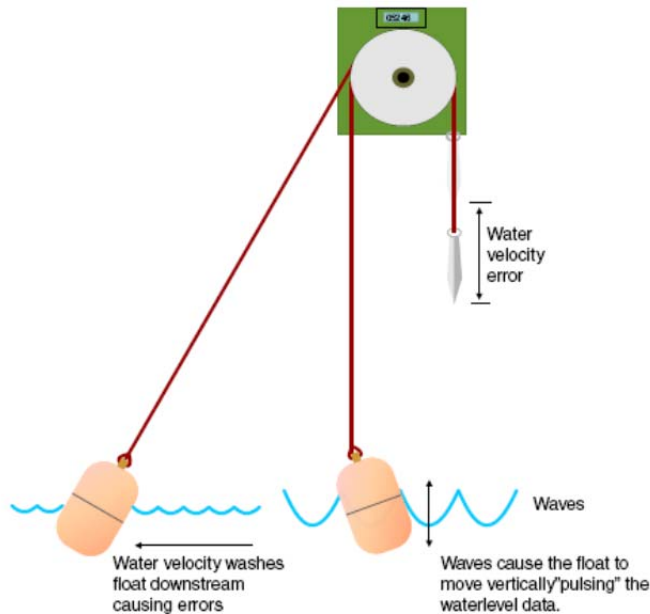

11.4.2 Siltation

Silt and sediment can collect in floatwells. This happens when silty water enters the well and the silt settles in the still water. If there are several entrances and exits through which water can flow, lots of silt can be deposited. In such cases there must be some way to clean out the well. Small wells can be washed out with a pump once the float system has been removed. Special designs may be required to enable larger wells to be cleaned easily.

Note that the atmosphere in deep float wells can be foul and dangerous and you should not enter them without taking precautions.

11.4.3 Environmental impact

Building structures in and near waterways can cause erosion and damage. Site operation can introduce and concentrate activities that may affect the local ecology. The site design, construction and operation should be planned to minimise such effects. Where appropriate, installations should be designed to blend in with their environment. Channel changes and structures should be kept to a minimum. Access paths should be established in ways that minimise damage. Provision should be made for any structures to be removed and the site restored to its original condition when the measurement project is complete.

11.4.4 Access and Security

All sites have to be constructed and operated. Good access will encourage operators to carry out regular inspections which will in turn improve the quality of the site data.

A major cause of data loss is interference by curious people or animals, and vandalism. All instruments should be inside locked cabinets and the floatwell design should not allow people to reach in and disturb the float system.

11.5 Other Features of a Floatwell Site

It is important that there is a permanent check gauge or measuring device near the floatwell from which the water level can be measured. This can be:

- A staff gauge or scale on a stable and permanent post located near the floatwell and surveyed to a known datum.
- A reference point at a known level from which a vertical distance can be measured to the water surface.

These measurements are used as a check to compare the levels recorded by the instrument system.